

# Hellwig PRODUCTS.com

559-734-7451 800-367-5480 FAX 559-734-7460

## INSTALLATION INSTRUCTIONS

### Rear Stabilizer Bar 5313

1966-77 Ford Bronco

Thank you for purchasing a quality Hellwig Product.

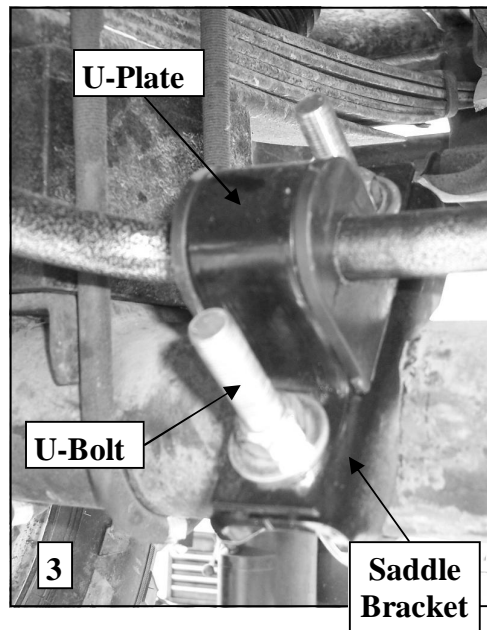
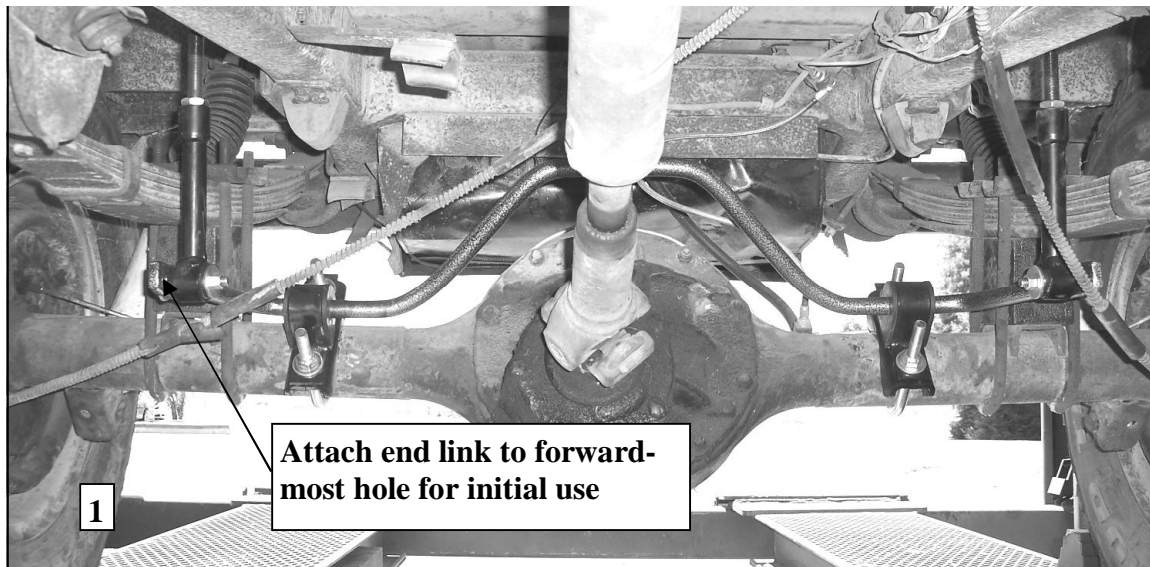

# Hellwig PRODUCTS.com

559-734-7451 800-367-5480 FAX 559-734-7460

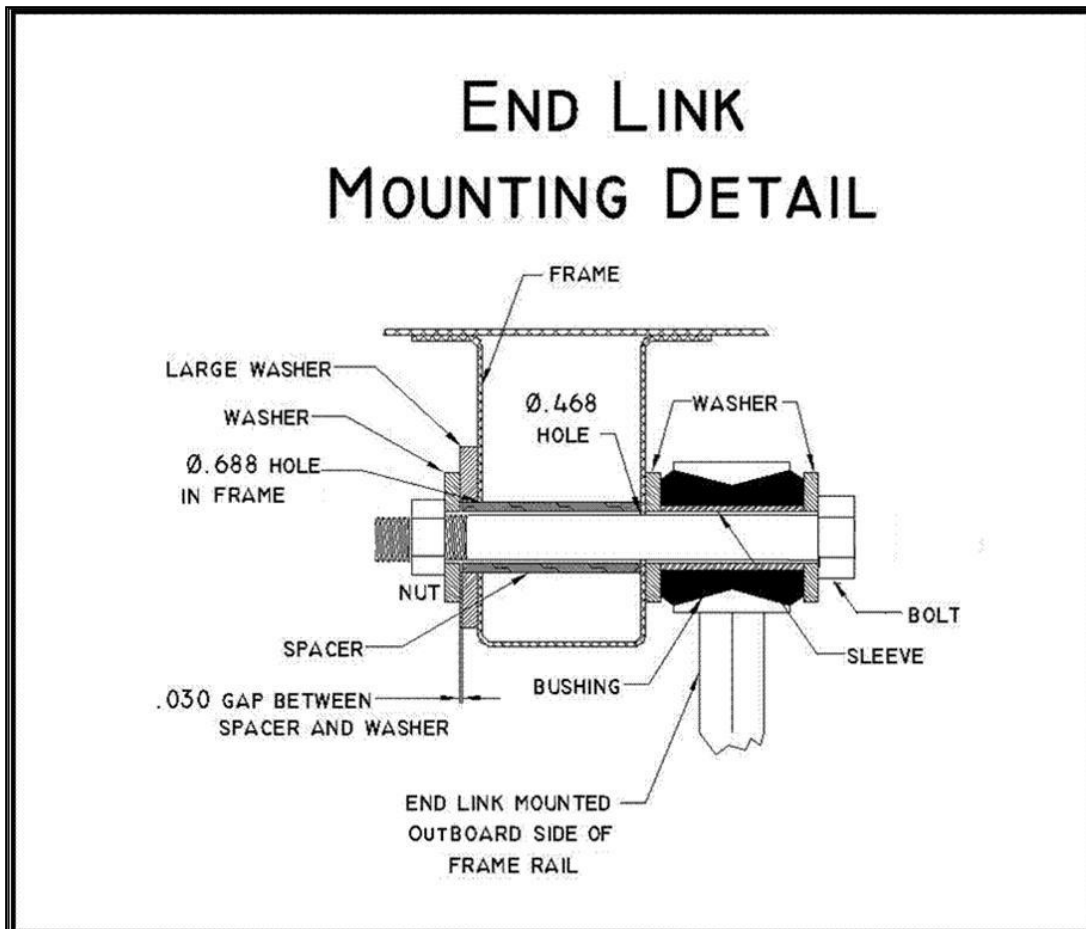

## TORQUE TABLE

Bolt Size 3/8"— 35 ft lbs \* Bolt Size 7/16"— 45 ft lbs\* Bolt Size 1/2"—75 ft lbs \*Bolt Size 9/16"— 90 ft lbs

**SAFETY: BEFORE BEGINNING INSTALLATION BE SURE TO SET THE PARKING BRAKE AND CHOCK THE WHEELS.**

**NOTE: TO EASE INSTALLATION AND PROPERLY ADJUST THE BAR, THE WEIGHT OF THE VEHICLE MUST BE ON THE SUSPENSION AS IF DRIVING DOWN THE ROAD. DO NOT RAISE THE VEHICLE BY THE FRAME.**

**NOTE: THIS KIT REQUIRES DRILLING THE FRAME RAIL AND POSSIBLE RELOCATION OF FUEL AND BRAKE LINES. INSTALLER MUST ENSURE THAT THE SWAY BAR KIT WILL NOT INTERFERE WITH ANY FUEL OR BRAKE LINES, HOSES, ELECTRICAL WIRING OR OTHER CHASSIS COMPONENTS.**

1. Lubricate the D shaped bushings and place them onto the straight areas of the bar on each side of the center hump as close to the outside bend as possible.
2. Hold bar up to the axle and locate the position on the axle tubes to mount the u-bolts. **Be sure to put the U-Bolts Under Any Brake Lines, Wires or Hoses on the Axle to Avoid Any Possible Damage.**

# Hellwig PRODUCTS.com

559-734-7451 800-367-5480 FAX 559-734-7460

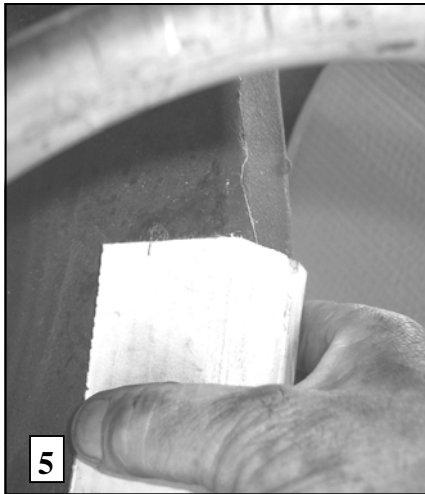

3. Place the saddle brackets onto the U-Bolts on the axle tubes. Place the U-Plates over the D shaped bushings on the bar and attach the bar to the U-Bolts and saddle brackets with the flat washers and stover nuts provided. The U-Plates will be rotated up on the axle to match PHOTO 1 and PHOTO 3. **LEAVE LOOSE AT THIS TIME** to allow for adjustment later.
6. Position sway bar on axle so that it clears all frame mounted components including fuel tanks, brake lines, fuel lines, etc. Sway bar can be rotated back and forth on axle to maximize clearance.
7. Assemble end links by inserting hourglass bushings into the end link hoop and then inner sleeve into the bushing. **Fully lubricate bushings before installation.** Install 9/16" nut on threaded section of end link before assembling the two halves together as shown. **IMPORTANT NOTE - The end link threads are NOT powder coated so that the end links can be threaded together. To prevent corrosion, it is advised to lightly coat the exposed threads with black spray paint after adjusting to desired length.**
8. Attach end links to the center hole of the sway bar and align end links for best fit as shown in PHOTO 4. **IMPORTANT NOTE – Center hole position is only for determining hole location. The end link will be moved to the outer hole prior to initial use.**
9. The end links should be located as shown in PHOTO 4 so that the arms of the sway bar are parallel with the ground. When satisfied with their location, mark location of holes for the end links.
10. Prepare to jack up vehicle by placing wheel chocks on the front wheels. After the rear of the vehicle has been raised, **support frame on jack stands** and remove rear wheels.
11. Transfer hole location to inner edge of frame rail. A piece of cardboard can be used by marking the location of the hole on the cardboard and transferring the location to the outer rail. Drawing a line on the frame square to the frame rails will keep the hole location square. See PHOTO 5,6&7.
12. **Review end link mounting detail before drilling holes. BEFORE DRILLING ANY HOLES IN THE RAIL— DISCONNECT BATTERY AND RELOCATE AND PROTECT ANY FUEL OR BRAKE LINES, WIRING, ETC. THAT MAY INTERFERE WITH THE DRILL BIT OR SWAY BAR INSTALLATION.**
13. Drill a 15/32 (.468) hole through **BOTH** walls of the frame. Make sure holes are square to one another when drilling holes.
14. Drill an 11/16 (.688) hole through **INNER** wall of frame **ONLY**.
15. Insert 7/16 X 6 bolt through rail as shown in PHOTO 8. Insert spacer sleeve into hole so that it is flush with the outboard wall of the frame. For severe duty it is recommended that the spacer tube be welded to the outer frame wall. **If the spacer is to be welded, review severe service end link detail on page 4 and skip to line 17. If any welding is to be done, the installer must ensure that all hazards (fuel, electrical, etc) are eliminated and that fuel tanks, fuel lines, brake lines, wiring, etc. are not affected by the welding operation.**
16. Install Large washer over spacer tube and check that spacer tube is 1/32" (.031") below the surface of large washer. Failure to do this will result in insufficient preload and noise. File or grind end of spacer tube to achieve proper length. SEE PHOTO 9.
17. Remove bolt and spacer and attach end link to frame as shown in detail and PHOTO 10. Applications with welded spacer do not require the washers on the inboard side of frame. Torque end link bolts to 35-40 ft-lb.
18. Replace rear wheels and torque lug nuts to factory specification. Lower vehicle so that the full weight of the vehicle is on the suspension.
19. Tighten axle u-bolts to 35 ft-lb.

# Hellwig PRODUCTS.com

559-734-7451 800-367-5480 FAX 559-734-7460

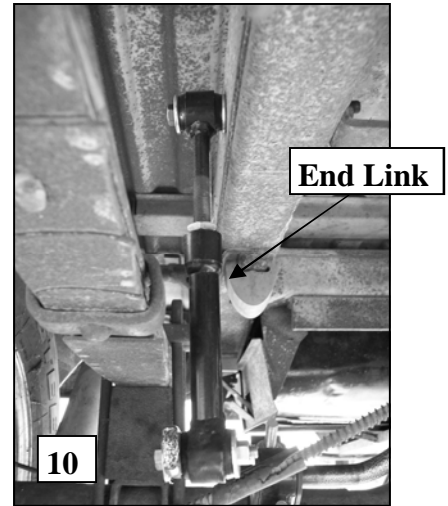
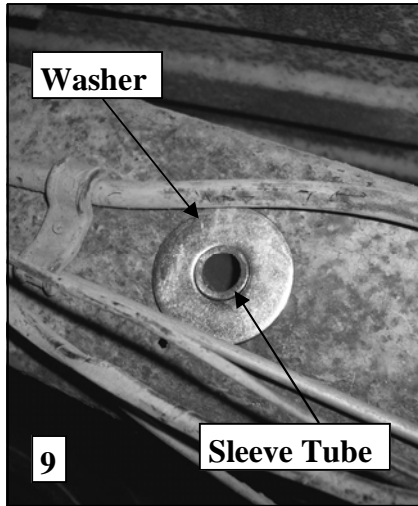

20. **Bounce the vehicle checking for clearance on all under carriage components: fuel tank, shocks, differential, brake and fuel lines, etc.** Test drive the vehicle and recheck all clearances and the installation alignment. Adjust as needed. Re-check your installation after one week of driving and periodically on a regular basis.
21. **The sway bars arms have three mounting holes. Mounting the sway bar on the outer hole (forward-most) is the nominal position. For a firmer setting, use the inner holes. We recommend starting with the outer mounting hole until you are accustomed to the vehicles new handling characteristics. Select the mounting point that best fits your driving style.**

**ATTENTION INSTALLER: BE SURE THAT THE CUSTOMER RECEIVES THIS INSTRUCTION SHEET, ALL IMORTANT NOTE CARDS AND THE WARRANTY FORM**

