

INSTALLATION INSTRUCTIONS: Universal Brake Cable

PART# 3756

Necessary Tools:
Side Cutting Pliers



865.938.6696 www.dufftuff.com
6609 Bronco Ln.
Knoxville, TN 37921

Please read all instructions before beginning.

Note: Lubricate Before Installing

1/1 2/07

1. Measure and cut spring

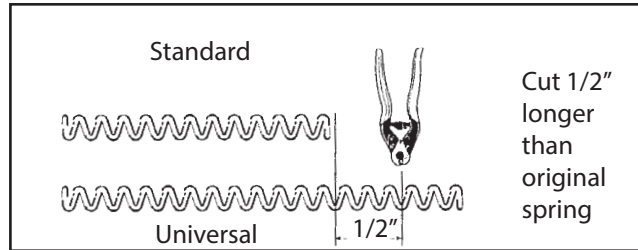

2. Measure and cut tipping

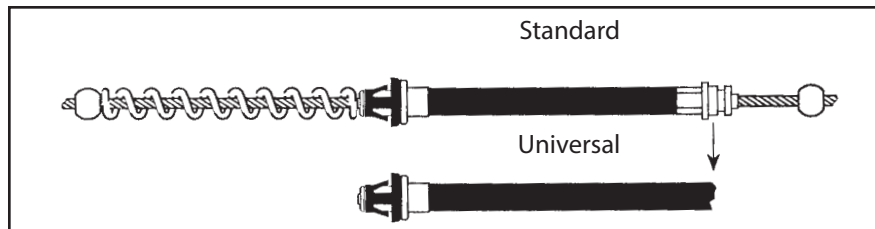

3. Mark wire with chalk
(Don't cut at this step)

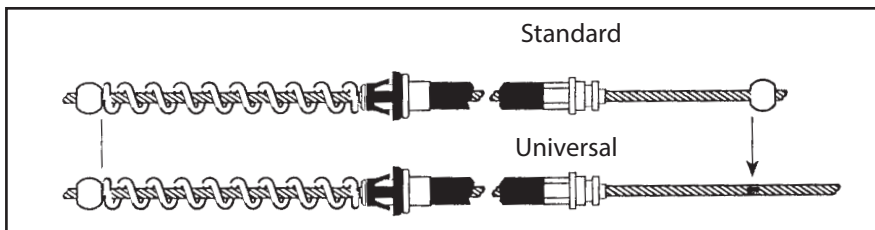

4. Cut off surplus after terminal is installed

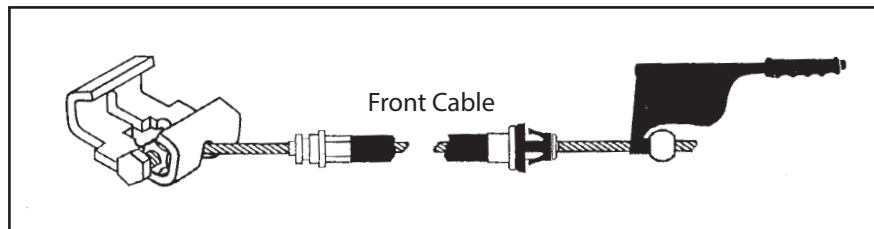
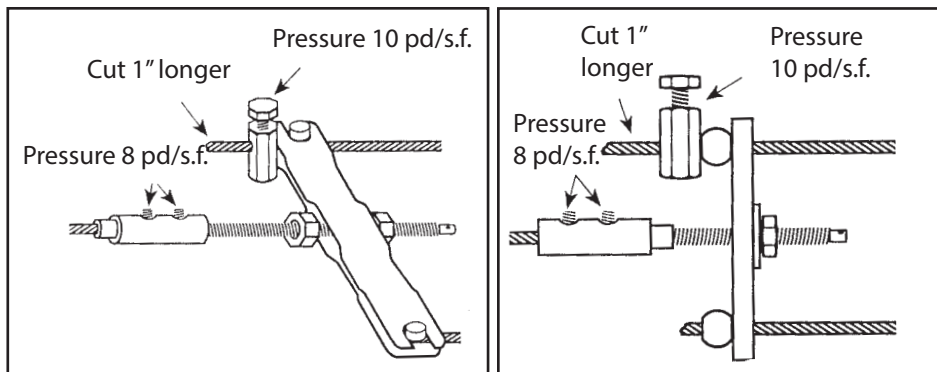

PC 7

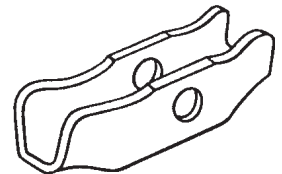

4505

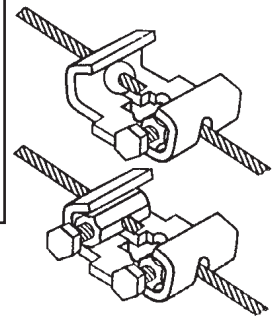

4601

LIMITED WARRANTY

James Duff Inc. warrants our products to the original purchaser to be free from defects in materials and workmanship. Warranty periods begin at the date of purchase and varies by product. Shocks have a limited lifetime warranty. Headers, Radiators and Suspension Products have a one year warranty. Power Brake Boosters and Master Cylinders have a three year warranty. Adapters and soft goods such as Canvas tops, upholstery, vinyl and rubber products have a 90 day warranty. All warranties are to the original purchaser with proof of purchase only. Such obligations under this warranty shall be limited to the repair or replacement, at JDI's discretion, of any assembly or part which upon examination by JDI proves to be defective. Any costs of removal, installation, reinstallation or freight charges are expressly excluded from this warranty. This warranty covers only manufacturers defects, and does not cover product finish or damage resulting from abuse, misuse, negligence, racing, alteration, accident or damage in transit.

All returns must be pre-authorized by JDEI and accompanied with a Return Goods Authorization Number (RGA) and a dated proof of purchase. Returns must be made within 90 days of purchase, shipped prepaid, packaged in original cartons to prevent damage in shipment and sent to JDI, 6609 Bronco Lane, Knoxville, TN 37921 Returns without an RGA# will be refused.

This warranty is expressly in lieu of all other warranties, expressed or implied, including the implied warranties of merchantability and fitness for use. This warranty gives you specific legal rights including other rights that vary from state to state. Some states do not allow limitations on how long an implied warranty lasts, or do not allow the exclusion of limitation of incidental or consequential damages, so the above limitations and/or exclusions may not apply to you.